

RA(R19A) Series

Rocker Switches



SPECIFICATION

- Electrical Rating : 2A 125V AC/250V AC(UL,VDE)
6A 250V AC(standard)(UL,VDE)
15A 125V AC & 8A 250V AC(UL)
- Mechanical life: Over 30000 cycles
- Electrical life: Over 10000 cycles
- Contact resistance: <20mΩ
- Insulation resistance: >1000MΩ
- High voltage resistance: >1500VAC 1 min.
- Ambient temperature: Terminal side -20 to +85°C
Actuating side- 20 to +55°C
- Atmospheric humidity: Max.85%
- Actuating force: 3 to 6N(depends on different switch function)
- Flammability: UL94V-2 & UL94V-0
- Storage temperature: -30 to +80°C Max
- Temperature rise at the terminal: Max 30°C (UL1054)
- Solder ability of terminal: Max 350°C 3s

MATERIALS

- Housing: PA 66
- Rocker: PA 66 & PC
- Contacts: Silver alloy
- Terminal: Copper or brass silver plated,phosphorus bronze
- Spring: SWC
- Movable arm: Copper silver plated
- Lamp: LED
- Bracket: PA66

HOW TO ORDER

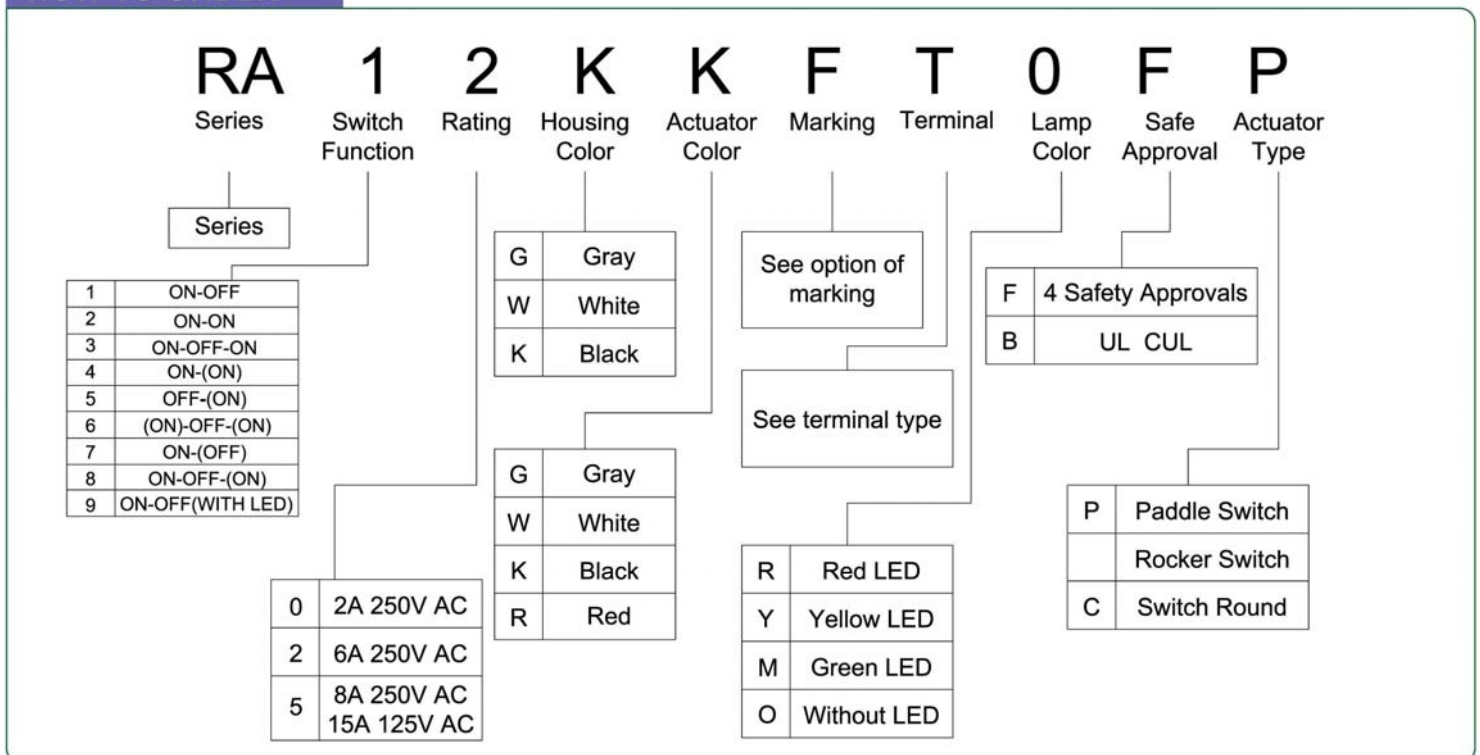

Option of switch function

Item No	POLES & THROWS	Rocker position ():Momentary		
		Left	Center	Right
RA1	SPST	ON	None	OFF
RA2	SPDT	ON	None	ON
RA3	SPDT	ON	OFF	ON
RA4	SPDT	ON	None	(ON)
RA5	SPST	OFF	None	(ON)
RA6	SPDT	(ON)	OFF	(ON)
RA7	SPST	ON	None	(OFF)
RA8	SPDT	ON	OFF	(ON)
RA9 (With LED)	SPST	ON	None	OFF

Dimension

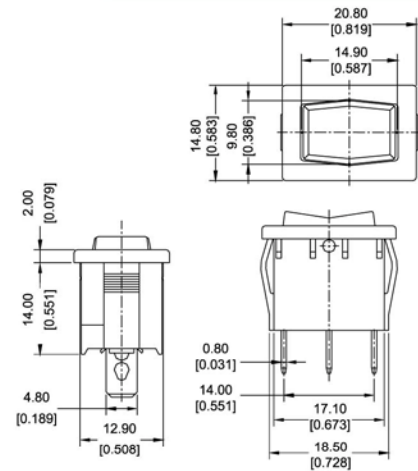

Panel cut out

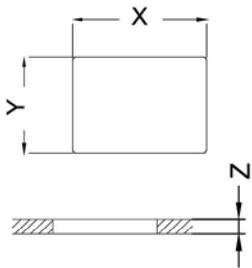

Z	Y	X
0.7~1.25	12.8~12.9	19.2~19.3
1.25~2.0	12.8~12.9	19.3~19.4
2.0~3.0	12.8~12.9	19.5~19.6

Circuits for switch with lamp

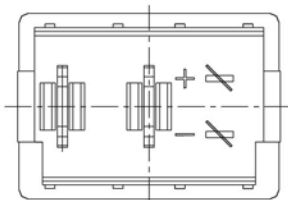

CIRCUIT FOR LOAD

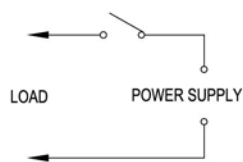

CIRCUIT FOR LED

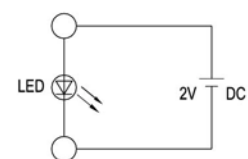

Terminal type

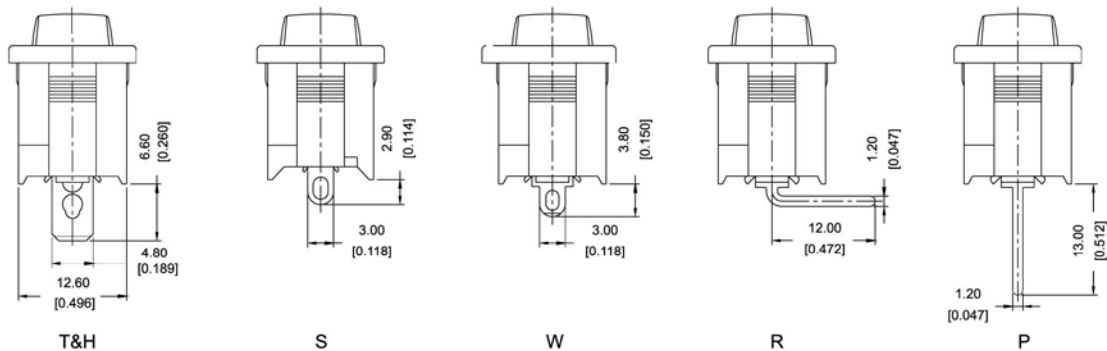

T(Quick connect tab:Thickness of 0.8mm)
H(Quick connect tab:Thickness of 0.5mm)